

Chapter 6 Hasp, Latch, Fastener, Door Catcher, and Locks



CAM LOCK stamped AISI 304
ITEM NO. **Weight/g**
008380 79



ECCENTRIC LATCH stamped AISI 304
ITEM NO. **Thickness** **Weight/g**
008370 1.5mm 62



ECCENTRIC LATCH stamped AISI 304
ITEM NO. **Thickness** **Weight/g**
008371 1.5mm 64g

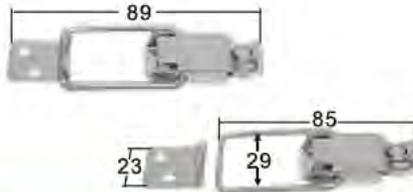

**ECCENTRIC LATCH WITH
PADLOCK RING** stamped AISI 304
ITEM NO. **Thickness** **Weight/g**
008361 1.5mm 44

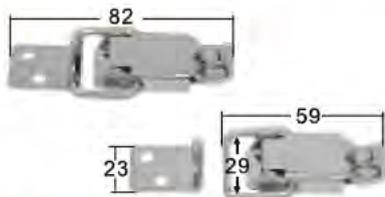

**ECCENTRIC LATCH WITH
PADLOCK RING** stamped AISI 304
ITEM NO. **Thickness** **Weight/g**
008360 1.5mm 40

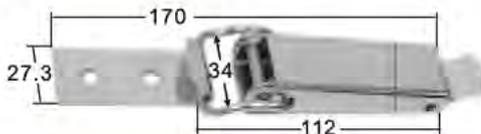

ECCENTRIC LATCH stamped AISI 304
ITEM NO. **Thickness** **Weight**
008358 2mm 180g

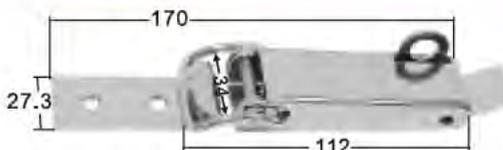

**ECCENTRIC LATCH WITH
PADLOCK RING** stamped AISI 304
ITEM NO. **Thickness** **Weight/g**
008359 2mm 154

Chapter 6

Hasp, Latch, Fastener, Door Catcher, and Locks

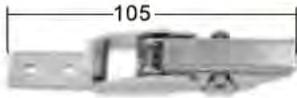

ECCENTRIC LATCH stamped **AISI 316**

ITEM NO.	Thickness	Weight/g
008353	1.5mm	50

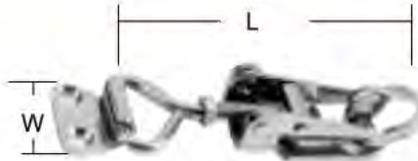
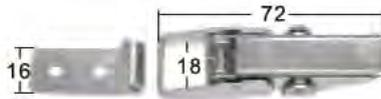

ECCENTRIC LATCH stamped **AISI 304**

thickness:1.5mm

ITEM NO.	adjustable L mm	W mm	Weight/g
008373	66~75	26	51
008369	115~125	30	116
008368	160~180	35	254



LIFT HANDLE LATCH

casted **AISI 316**

Highly-polished

ITEM NO.	Base mm
007185	Φ50x50x19



LIFT HANDLE LATCH

casted **AISI 316**

Highly-polished

ITEM NO.	Base mm	Weight/g
007184	Φ50x19	84



FLUSH RING PULLS ROUND

precision casted **AISI 316**

ITEM NO.	Dia base	Thickness	Weight/g
007050	50mm(2")	2.5mm	46



ROUND RING WITH RETURN CLIP

stamped **AISI 304**

ITEM NO.	Φmm	Weight/g
007055	55	29

on request **AISI 316**



SQUARE FLUSH RING PULL casted **AISI 316**

ITEM NO.	Size	Fastener	Weight/g
007194	1-7/8"x1-1/2"(47x35mm)	#5	43

Chapter 6

Hasp, Latch, Fastener, Door Catcher, and Locks



PADLOCKABLE LATCH

stamped **AISI 304**

drilling distance 47mm, screw for ground plate M6, screw for counter plate M4.

ITEM NO.	L mm	Weight
008394	93	82g

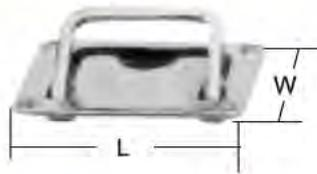

FLUSH LIFTING HANDLE precision casted **AISI 316**

ITEM NO.	LXW mm	Handle mm	Weight/g
007195	95x70(3-3/4"x2-3/4")	70x40(3-3/4"x1-9/16")	224
007196	75x57(3"x2-1/4")	57x35(2-1/4"x1-3/8")	164



FLUSH RING CATCH casted **AISI 316**

ITEM NO.	Base mm	Weight/g
007100	57x35(2-1/4"x1-3/8")	62
007101	62x44(2-1/2"x1-3/4")	110
007102	70x57(2-3/4"x2-1/4")	180



FLUSH RING CATCH casted **AISI 316**

ITEM NO.	Base mm	Weight/g
007103	57x76mm(2-1/4"x3")	162



LIFTING EYE stamped **AISI 304**

ITEM NO.	L mm	W mm	Weight/g
006001	89	25	63

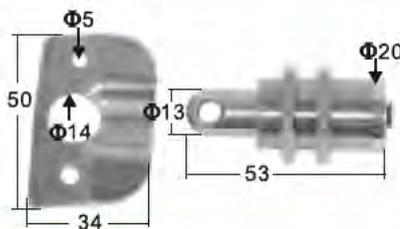

LOCKER SEAT LOCK **AISI 304**

with closing lip. with twistlock for locking by a pad lock.

ITEM NO.	Weight/g
007104	98

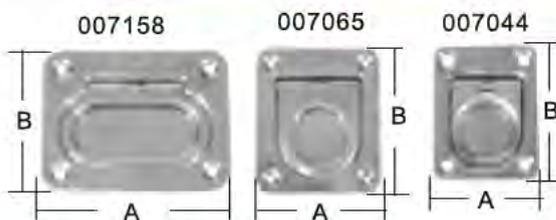

FLOOR RING with return clip

stamped **AISI 304**

ITEM NO.	A mm	B mm	Weight/g
007045	38	44	on request
007065	56	66	on request
007158	75	58	50
007044	44	57	on request

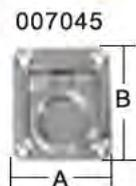

Chapter 6 Hasp, Latch, Fastener, Door Catcher, and Locks

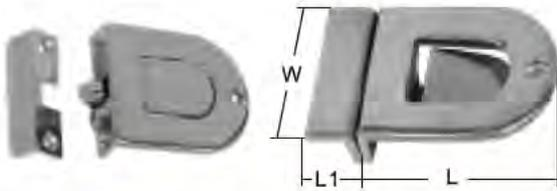

FLUSH RING WITH PUSH BOTTOM casted AISI 316

ITEM NO.	L	L1	W	Weight/g
007105	52mm	13mm	44mm	100



LIFT HANDLE LATCH casted AISI 316

Highly-polished

ITEM NO.	Base mm	Height mm	Weight/g
007106	Φ62(2.44")	38(1-1/2")	230



LIFT HANDLE LATCH casted AISI 316

Highly-polished, with lock

ITEM NO.	Base mm	Height mm	Weight/g
007199	Φ62(2.44")	38(1-1/2")	250



LIFT HANDLE LATCH casted AISI 316

Highly-polished

ITEM NO.	Base mm	Thickness	Weight/g
007181	Φ62(2.44")	0~8 mm	250



LIFT HANDLE LATCH casted AISI 316

Highly-polished, with lock

ITEM NO.	Base mm	Thickness	Weight/g
007182	Φ62(2.44")	0~8 mm	260



DOOR LOCK HOOK casted AISI 316

with double swivel

ITEM NO.	L mm	Weight/g
060901	70(2-3/4")	62
060903	90(3-9/16")	69
060904	120(4-3/4")	75



CABIN DOOR HOOK stamped AISI 304

A plastic bushing in the eye prevents assidental unhooking due to vibration

ITEM NO.	Length	Weight/g
008377	64mm(2-1/2")	40
008378	84mm(3-5/16")	44
008382	120mm(4-3/4")	52

Chapter 6

Hasp, Latch, Fastener, Door Catcher, and Locks



CABIN DOOR HOOK casted **AISI 316**

ITEM NO.	Length mm	Weight/g
008379	77(3")	66

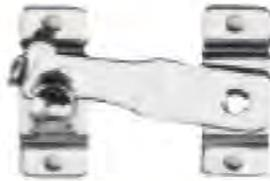

BAR LATCH stamped **AISI 304**

ITEM NO.	Length	Weight/g
008383	47mm(1-27/32")	22
008384	58mm(2-9/32")	39
008385	84mm(3-5/16")	

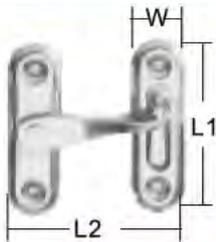

ROUGH REAMER stamped **AISI 304**

ITEM NO.	L1 mm	L2 mm	W mm	Weight/g
003100	63(2-1/2")	60(2-3/8")	19(3/4")	46



ROUGH REAMER **AISI 316**

ITEM NO.	L1 mm	L2 mm	Weight/g
003102	38(1-1/2")	40(1-9/16")	34



STAINLESS BARREL BOLTS precision casted **AISI 316**

ITEM NO.	Overall	Size	Weight/g
008354	60mmx30mm	(2-3/8"x1-3/16")	72
008355	89mmx39mm	(3-1/2"x1-1/2")	132
008356	115mmx39mm	(4-1/2"x1-1/2")	166



LOCKABLE STAINLESS BARREL BOLT precision casted **AISI 316**, less pad lock

ITEM NO.	Overall	Size	Weight/g
008396	60mmx30mm	(2-3/8"x1-3/16")	68
008397	89mmx39mm	(3-1/2"x1-1/2")	116



BARREL BOLT precision casted **AISI 316**
good for small door

ITEM NO.	Overall	Size	Weight/g
008357	60mmx30mm	(2-3/8"x1-3/16")	72

Chapter 6

Hasp, Latch, Fastener, Door Catcher, and Locks



SQUARRE BARREL BOLT casted AISI 316

Spring closing, contemporary shaped barrel bolt

ITEM NO.	Length	Width	Depth	Weight/g
008398	90 mm	30 mm	32 mm	273



ANTI-RATTLE DOOR FASTENERS

ITEM NO.	Closed size mm	Quality	Weight/g
060900	115x50(4-1/2"x2")	Brass N/P	
060905	110x50(4-3/8"x2")	AISI 316 casted	144
060906	105x50(4-1/8"x2")	AISI 316 casted	128
060907	95x50(3-3/4"x2")	AISI 316 casted	103



ANTI-RATTLE DOOR FASTENERS

precision casted AISI 316

ITEM NO.	Closed size	Weight/g
060910	100x50(4"x2")	126



HATCH FASTENER casted AISI 316

ITEM NO.	Closed Length	Width	Weight/g
008364	100mm(4")	30mm(1-3/16")	93



HATCH FASTENER casted AISI 316

ITEM NO.	Closed Length	Width	Weight/g
008365	92mm(3-5/8")	30mm(1-3/16")	96



HOLD DOWN CLAMP casted AISI 316

ITEM NO.	Base	Screws	Weight/
008301	L3"xW1-1/2"(75x38mm)	#8	161



HOLD DOWN CLAMP casted AISI 316

90° angle mounting

ITEM NO.	Base	Screws	Weig
008300	L2-1/2"xW1-1/2"(64x38mm)	#8	163

Chapter 6

Hasp, Latch, Fastener, Door Catcher, and Locks



LOCKABLE HOLD DOWN CLAMP casted AISI 316

90° angle mounting, padlocks not included

ITEM NO.	Base	Screws	Weight/g
008307	L2-1/2"x1-1/2"(64x38mm)	#8	169



LOCKABLE HOLD DOWN CLAMP casted AISI 316

flat mounting, padlocks not included

ITEM NO.	Base	Screws	Weight/g
008303	L3"xW1-1/2"(75x38mm)	#8	168



LOCKABLE HOLD DOWN CLAMP casted AISI 316

90° angle mounting, padlocks not included

ITEM NO.	Base	Screws	Weight/g
008304	L2-1/2"x1-1/2"(64x38mm)	#8	170



HOOD LATCH

for engine rooms stainless steel parts.

ITEM NO.	Length	Weight/g
008351	70mm	50



HOOD LATCH

with removable pin with frost resistant rubber stainless steel parts

ITEM NO.	Length	Weight/g
008352	130mm	85



STUD CATCHES casted AISI 316

ITEM NO.	Overall size	Weight/g
003680	1-3/4"x5/16" (44x8mm)	15
003681	2"x3/8" (50x9mm)	24
003682	2-1/4"x7/16" (57x11mm)	31



ELBOW CATCH casted AISI 316

ITEM NO.	Base mm	Weight/
003672	16x28 (5/8"x1-1/8")	26

Chapter 6

Hasp, Latch, Fastener, Door Catcher, and Locks

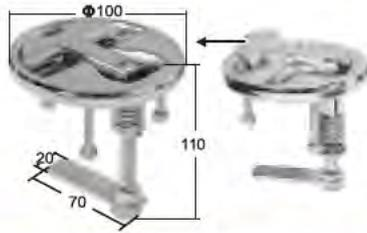

QUICK OPENING COMPRESSION

LATCH Stamped **AISI 316**

lift handle straight bar

ITEM NO. Weight/g

008349 464



LIFT HANDLE casted **AISI 316**

ITEM NO. Weight/g

007188 with lock 215

007189 without lock 193

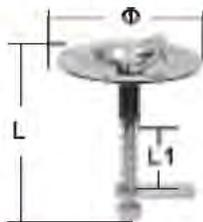

LIFT HANDLE stamped **AISI 316**

Lockable

ITEM NO. L1mm Lmm Φ mm Weight/g

007191 30 78 97 279



LIFT HANDLE stamped **AISI 316**

Lockable with retrogressive spring and stop cam not included

ITEM NO. L mm Φ mm Weight/g

007192 78,5 70 220 Angle

007183 78,5 70 210 straight

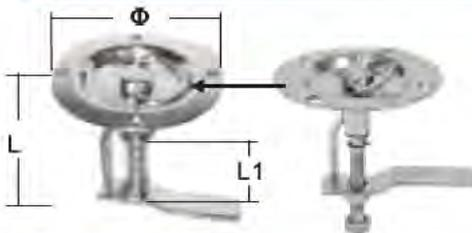

LIFT HANDLE stamped **AISI 316**

Lockable with retrogressive spring and stop

ITEM NO. L1 mm L mm Φ mm Weight/g

007190 60 110 97 320

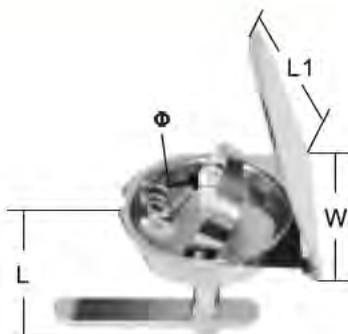

LIFT HANDLE stamped **AISI 316**

Lockable with padlock-holder and thread closing plug-internal security opening

ITEM NO. L mm L1 mm W mm Φ mm Weight/g

007197 100 110 100 80 458

Chapter 6 Hasp, Latch, Fastener, Door Catcher, and Locks



BUTTON LATCH stamped AISI 304

plastic slide and knob

ITEM NO.	overall dimension	Screws	Weight/g
008302	2-1/8"x1-1/2"(54x38mm)	#6	52



BUTTON LATCH AISI 316

Sliding lock button requires #6 FH screws (not included)

ITEM NO.	Size	Weight/g
007202	(54x57mm)2-1/8"x2-1/4"	142



CUPBOARD CATCH casted AISI 316

includes box strike

ITEM NO.	Dimension overall mm	Weight/g
008309	38x47.6(1-1/2"x1-7/8")	102



DOOR HOLDER

ITEM NO.	base		plate	Quality	Weight/g
	L mm	W mm	H mm		
003675	41	33	31	AISI 304 stamped	110
003676	34	16	23	AISI 304 stamped	46
003677	41	33	31	plastic knob	
003678	34	16	23	plastic knob	27



DOOR STOP AND CATCHER

casted AISI 316

ITEM NO.	Weight/g
003674	154



MAGNET DOOR CATCHER casted AISI 316

adjustable the room between the door.

ITEM NO.	Weight/g
003683	380



DOOR STOP AISI 316

provides cushion for door knobs and protects bulkheads.

ITEM NO.	Height	O.D.	Fastener	Weight/g
003673	19mm(3/4")	50mm(2")	#6	35